

Dell PowerConnect
RPS720, MPS600, MPS1000,
and MPS 1U Shelf

Getting Started With Your System

Regulatory Model PowerConnect RPS720,
MPS600, and MPS1000



Notes, Cautions, and Warnings



NOTE: A NOTE indicates important information that helps you make better use of your computer.



CAUTION: A CAUTION indicates potential damage to hardware or loss of data if instructions are not followed.



WARNING: A WARNING indicates a potential for property damage, personal injury, or death.

Information in this publication is subject to change without notice.

© 2010 Dell Inc. All rights reserved.

Reproduction of these materials in any manner whatsoever without the written permission of Dell Inc. is strictly forbidden.

Trademarks used in this text: Dell™, the DELL logo, and PowerConnect™ are trademarks of Dell Inc. EMC® is a registered trademark of EMC Corporation.

Other trademarks and trade names may be used in this publication to refer to either the entities claiming the marks and names or their products. Dell Inc. disclaims any proprietary interest in trademarks and trade names other than its own.

Regulatory Model PowerConnect RPS720, MPS600, and MPS1000

November 2010

P/N KPCT8

Rev. A00

Features

Dell PowerConnect RPS720

Figure 1-1. Front Panel Indicators-PowerConnect RPS720

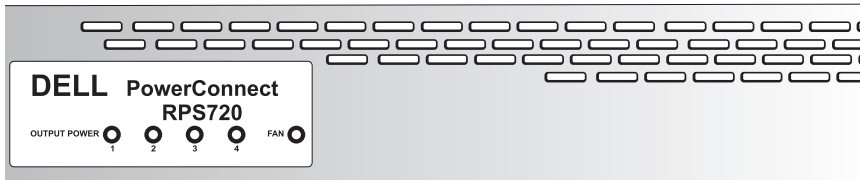

- Supports up to four PowerConnect switches through 12 V DC output
- Dedicated 180 W power supply for up to four connected switches
- Front panel LEDs display status of individual power supplies
- 1U, 19-inch rack mountable system



NOTE: The PowerConnect RPS720 redundant power bank provides four external redundant power supplies for your PowerConnect switches, eliminating the power supply as a single point of failure.

Dell PowerConnect MPS600

Figure 1-2. Front Panel Indicators-PowerConnect MPS600

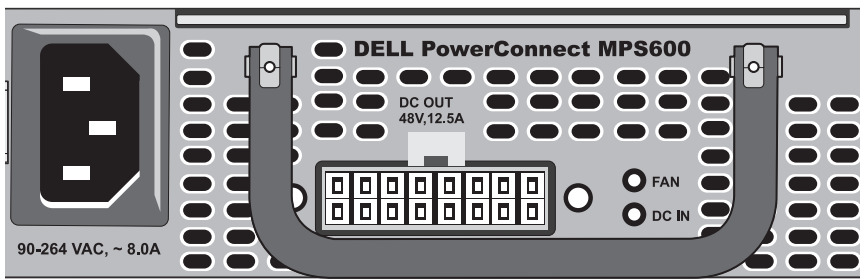

- Supports one PowerConnect 55xxP (PoE) switch through 48 V DC output
- Dedicated 600 W power supply for one connected switch
- Front panel LEDs display status of the power supply

- 1U, 19-inch rack mountable system with brackets
- Up to three MPS600 units in a MPS 1U Shelf (density=3per 1U, 19-inch rack)

Dell PowerConnect MPS1000

Figure 1-3. Front Panel Indicators–PowerConnect MPS1000

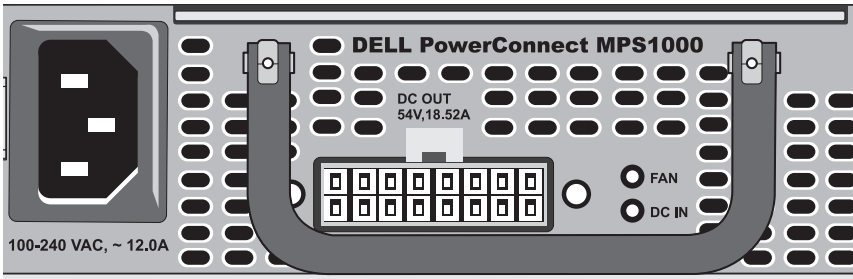

- Supports one PowerConnect 70xxP (PoE+) switch through 54 V DC output
- Dedicated 1000 W power supply for one connected switch
- Front panel LEDs display status of the power supply
- 1U, 19-inch rack mountable system with brackets
- Up to three MPS1000 units in a MPS 1U Shelf (density=3 per 1U, 19-inch rack)

Unpacking

Package Contents

Before you install the RPS720, MPS600, MPS1000, or MPS 1U Shelf, verify your package contents for:

- One of the following units:
 - RPS720—Redundant power bank (supports up to four switches)
 - MPS600—Modular power supply 600 watts
 - MPS1000—Modular power supply 1000 watts
 - MPS 1U Shelf—Mechanical shelf holds up to three MPS600, MPS1000, or a combination

- Rack mounting kit
- AC power cord:
 - RPS720—Type C13 plug
 - MPS600—Type C13 plug
 - MPS1000—Type C15 plug (with notch)
- Switch DC power cords:
 - RPS720—14-pin DC power cords (4)
 - MPS600—16-pin DC power cord (1)
 - MPS1000—16-pin DC power cord (1)

Installation

 **WARNING:** Before performing the following procedure, review the safety instructions that came with the system.

 **CAUTION:** Before you install the PowerConnect RPS720, MPS600, or MPS1000, consult your PowerConnect Switch User's Guide to confirm that your switch supports the PowerConnect RPS720 redundant power bank or the MPS600/MPS1000 external power supply.

PowerConnect RPS720

Installing PowerConnect RPS720 on a Flat Surface

You can install the PowerConnect RPS720 on any appropriate level surface that can safely support the weight of the switches, the PowerConnect RPS720, and their attached cables. There must be adequate space around the PowerConnect RPS720 for ventilation and to access cable connectors.

 **CAUTION:** Allow at least 2 inches (5.1 cm) on each side for proper ventilation and 5 inches (12.7 cm) at the back for power cord clearance.

- 1 Set the RPS720 on a flat surface and check for proper ventilation.
- 2 Attach rubber feet (optional) on each marked location at the bottom of the chassis.

 **NOTE:** Although optional, rubber feet are recommended to keep the unit from slipping.

Installing PowerConnect RPS720 in a Rack

The PowerConnect RPS720 can be installed in most standard 19-inch racks.

 **NOTE:** For racks that are not pre-threaded, cage nuts are provided.

Figure 1-4. Attaching Mounting Brackets—PowerConnect RPS720



- 3** Use the screws that are provided to attach a mounting bracket to each side of the PowerConnect RPS720.
- 4** Position the PowerConnect RPS720 in the rack and align the holes in the mounting bracket with the holes in the rack.
- 5** Insert and tighten two screws through each of the mounting brackets.

Operating the PowerConnect RPS720 After Installation

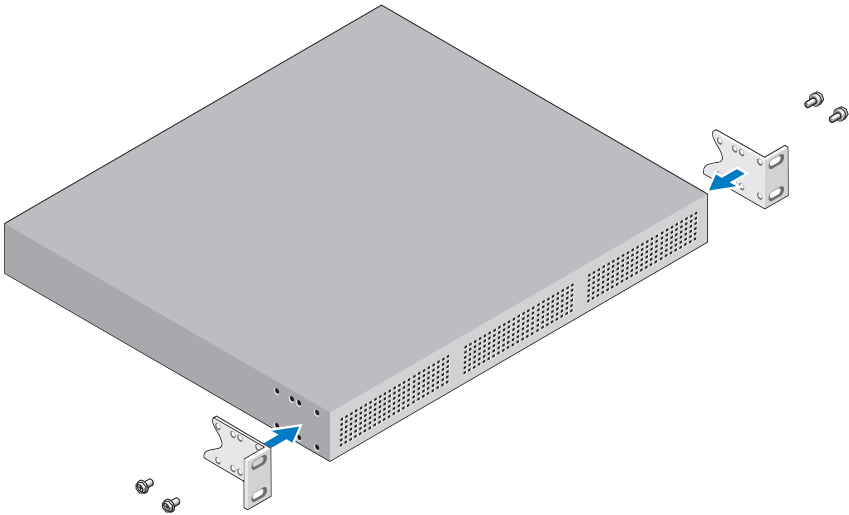
- 1 Plug one end of the switch DC power cord (14-pin) into the connector labeled **RPS** on the back of the switch. Connect the other end of the switch DC power cord to any available RPS connector on the back of the PowerConnect RPS720.

Figure 1-5. Back View—PowerConnect RPS720

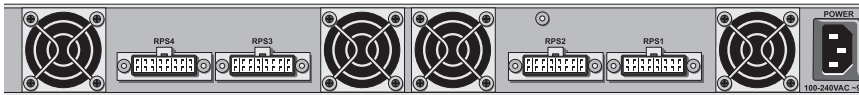

- 2 Attach the AC power cord to the PowerConnect RPS720 and to an AC power outlet.

The switch is now using both power supplies simultaneously. You can monitor the status of the two power supplies through the front panel LEDs on your PowerConnect switch and the PowerConnect RPS720.

PowerConnect MPS600 or MPS1000

Installing PowerConnect MPS600 or MPS1000 on a Flat Surface

You can install the PowerConnect MPS600 or MPS1000 on any appropriate level surface that can safely support the weight of the switch, the PowerConnect MPS600 or MPS1000, and their attached cables. There must be adequate space around the PowerConnect MPS600 or MPS1000 for ventilation and to access cable connectors.

⚠ CAUTION: Allow at least 2 inches (5.1 cm) on each side for proper ventilation and 5 inches (12.7 cm) at the back for power cord clearance.

- 1 Set the PowerConnect MPS600 or MPS1000 on the flat surface and check for proper ventilation.
- 2 Attach rubber feet (optional) on each marked location at the bottom of the chassis.

📌 NOTE: Although optional, rubber feet are recommended to keep the unit from slipping.

Installing PowerConnect MPS600 or MPS1000 in a Rack

The PowerConnect MPS600 or MPS1000 can be installed in most standard 19-inch racks.

 **NOTE:** For racks that are not pre-threaded, cage nuts are provided.

Figure 1-6. Attaching Mounting Brackets—PowerConnect MPS600 or MPS1000



- 3 Use the screws that are provided to attach a mounting bracket to each side of the PowerConnect MPS600 or MPS1000.
- 4 Position the PowerConnect MPS600 or MPS1000 in the rack and align the holes in the mounting bracket with the holes in the rack.
- 5 Insert and tighten two screws through each of the mounting brackets.

Operating the PowerConnect MPS600 or MPS1000 After Installation

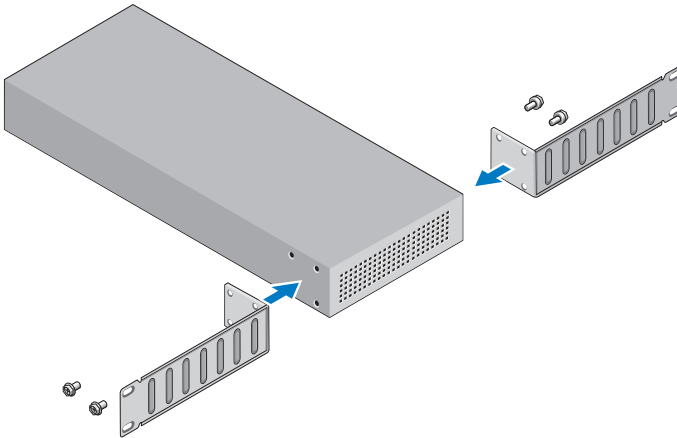
- 1 Plug one end of the switch DC power cord (16-pin) into the connector labeled **MPS** on the back of the switch. Connect the other end of the switch DC power cord to the DC OUT connector on the back of the PowerConnect MPS600 or MPS1000.

Figure 1-7. Back View–PowerConnect MPS600/MPS1000

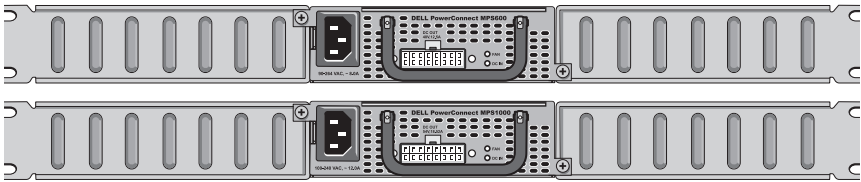

- 2 Attach the AC power cord to the MPS600 or MPS1000 and to an AC power outlet.

The switch is now using both power supplies simultaneously. You can monitor the status of the two power supplies through the front panel LEDs on your PowerConnect switch and the MPS600 or MPS1000.

PowerConnect MPS 1U Shelf

Installing PowerConnect MPS 1U Shelf on a Flat Surface

You can install the PowerConnect MPS 1U Shelf on any appropriate level surface that can safely support the weight of up to three switches, up to three PowerConnect MPS600 or MPS1000, and their attached cables. There must be adequate space around the PowerConnect MPS 1U Shelf for ventilation and to access cable connectors.

CAUTION: Allow at least 2 inches (5.1 cm) on each side for proper ventilation and 5 inches (12.7 cm) at the back for power cord clearance.

- 1 Set the PowerConnect MPS 1U Shelf on the flat surface and check for proper ventilation.
- 2 Attach rubber feet (optional) on each marked location at the bottom of the chassis.

NOTE: Although optional, rubber feet are recommended to keep the unit from slipping.

Installing PowerConnect MPS 1U Shelf in a Rack

The PowerConnect MPS 1U Shelf can be installed in most standard 19-inch racks.

 **NOTE:** For racks that are not pre-threaded, cage nuts are provided.

- 1 Use the screws that are provided to attach a mounting bracket to each side of the PowerConnect MPS 1U Shelf.
- 2 Position the PowerConnect MPS 1U Shelf in the rack and align the holes in the mounting bracket with the holes in the rack.
- 3 Insert and tighten two screws through each of the mounting brackets.

Operating the PowerConnect MPS600 or MPS1000 in the MPS 1U Shelf After Installation

- 1 Install up to three PowerConnect MPS600 or MPS1000 (or combinations) into the MPS 1U Shelf.

Figure 1-8. Back View–PowerConnect MPS 1U Shelf

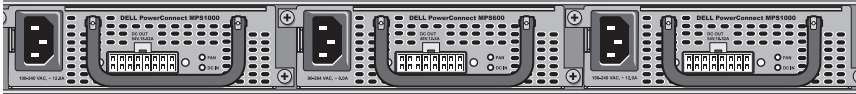

- 2 Plug one end of the switch DC power cord (16-pin) into the connector labeled **MPS** on the back of an available switch. Connect the other end of the switch DC power cord to the **DC OUT** connector on the back of an available PowerConnect MPS600 or MPS1000.
- 3 Attach the AC power cord to the PowerConnect MPS600 or MPS1000 and to an AC power outlet.

The switches are now using both power supplies simultaneously. You can monitor the status of the all the power supplies through the front panel LEDs on your PowerConnect switches and the PowerConnect MPS600s or MPS1000s.

Other Information You May Need

 **WARNING:** See the safety and regulatory information that shipped with your system. Warranty information may be included within this document or as a separate document.

- The rack documentation included with your rack solution describes how to install your system into a rack.
- The PowerConnect Switch User Guides provide information about system features and describes how to troubleshoot the system and install or replace system components. These documents are available online at support.dell.com/manuals.

 **NOTE:** Always check for updates on support.dell.com/manuals and read the updates first because they often supersede information in other documents.

Obtaining Technical Assistance

If you need help with a technical problem, see the Dell Support website at support.dell.com for the latest updates on documentation and firmware.

Technical Specifications

PowerConnect RPS720

The PowerConnect RPS720 contains four independent 180 W power supplies.

Physical

Height	43.2 mm (1.7 in)
Width	440 mm (17.32 in)
Depth	257 mm (10.18 in)

180 W AC-DC power supply

NOTE: The power supply has an universal input (90 VAC to 264 VAC) and a 12 VDC regulated output. This regulated output supplies power to other power supply backup source. The power supply incorporates over current protection and OVP.

Input Voltage	Universal input– 90 to 264 VAC Nominal input– 15 to 230 VAC.
Input Frequency Range	47 to 63 Hz
Max. Input AC Current	2.3 A max per supply (9.2 A total for four supplies in PowerConnect RPS720)
Output Voltage and Current	
Parameter	12 V output unit
Nominal Output Voltage	+12 V
Absolute Maximum Tolerance	+/- 5 %
Output Ripple Voltage	500 mV pk-pk
Minimum Current	0.0 A
Maximum Current	15 A

DC FAN Specification

Bearing Type	Two-ball bearing
Rated Voltage	12 V DC
Operating Voltage Range	7.0 V–13.8 V
Speed (Reference Value)	9000 RPM
Air Delivery	10.10 CFM
Noise	32.5dB
Operating Temperature	-20 to +70 °C
Storage Temperature	-40 to +70 °C

PowerConnect MPS600

The PowerConnect MPS600 contains a 600 W power supply.

Physical

Height	41.6 mm (1.64 in)(maximum)
Width	133.8 mm (5.27 in)(maximum)
Depth	401.4 mm (15.8 in)(maximum)

600 W AC-DC power supply

NOTE: The power supply has an universal input (90 VAC to 264 VAC) and a 12 VDC regulated output. This regulated output supplies power to other power supply backup source. The power supply incorporates over current protection and OVP.

Input Voltage	Universal input– 90 to 264 VAC
Input Frequency Range	47 to 63 Hz, single phase AC
Max. Input AC Current	8.0 A (maximum)
Output Voltage and Current	
No of Output	1
Nominal Output Voltage Set Point	48 V DC
Set Point Tolerance	+/- 1%
Total Error Band	+/- 2%
Minimum Current	1.0 A
Maximum Current	12.5 A

PowerConnect MPS1000

The PowerConnect MPS1000 contains a 1000 W power supply.

Physical

Height	41.6 mm (1.64 in)(maximum)
Width	133.8 mm (5.27 in)(maximum)
Depth	401.4 mm (15.8 in)(maximum)

1000 W AC-DC power supply

NOTE: The power supply has a universal input (100 VAC to 240 VAC). This regulated output supplies power to other power supply backup source. The power supply incorporates over current protection and OVP.

Input Voltage	Universal input– 100 to 240 VAC
Input Frequency Range	47 to 63 Hz, single phase AC
Max. Input AC Current	12.0 A (maximum)
Output Voltage and Current	
No of Output	1
Nominal Output Voltage Set Point	48 V DC
Set Point Tolerance	+/- 1%
Total Error Band	+/- 2%
Minimum Current	1.0 A
Maximum Current	18.52 A

PowerConnect MPS 1U Shelf

Physical

Height	44 mm (1.73 in)(maximum)
Width	440 mm (17.32 in)(maximum)
Depth	402 mm (15.83 in)(maximum)

PowerConnect RPS720, MPS600, and MPS1000

Environmental Considerations

NOTE: For additional information about environmental measurements for specific system configurations, see www.dell.com/environmental_datasheets.

Temperature	
Operating	0° to 45°C (32° to 113°F)
Relative humidity	
Operating	0% to 95% (noncondensing)
Altitude	
Operating	0 to 3,048 m (0 to 10,000 ft)